

NOTES:

TRANSMISSION PERFORMANCE:

- ANSI/TIA-568-C.2, category 5E

ENVIRONMENTAL:

- Storage temperature: -40 °C--+70 °C (-40 °F--+158 °F)
- Operation temperature: -10 °C--+60 °C (+14 °F--+140 °F)
- RH (operation): max non-condensing 93 %

ELECTRICAL:

- Insulation resistance: min 500 MOhm @ 100 V_{dc}
- Dielectric withstanding voltage: 1000 V_{dc/ac} peak contact-to-contact @ 60 Hz for 1 min
1500 V_{dc/ac} peak contact-to-panel @ 60 Hz for 1 min
- Spring wire contact resistance: max 20 mOhm
- IDC contact resistance: max 2.5 mOhm

MECHANICAL:

- Retention: 50 N (11 lbf) for 60 ± 5 s
- Mating cycle life: min 750 cycles
- IDC wire gauge: 22-24 AWG (0.644-0.511 mm)

CONSTRUCTION:

- Housing: zinc alloy
- Jack spring wire: phosphor bronze alloy plated with 50 microinches of gold over 70-100 microinches of nickel
- IDC: 110 type, phosphor bronze alloy with 100 microinches of 100% tin alloy

| REVISIONS | | | | |
|-----------|-----|-----------------------|--------|----------|
| ZONE | REV | DESCRIPTION | DATE | APPROVED |
| | A | A-MAY-10 KJS458TL-C5E | MAY'10 | |

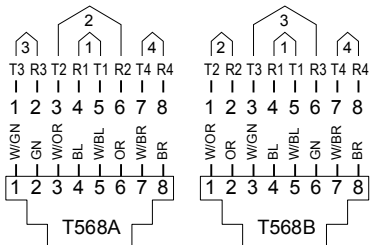
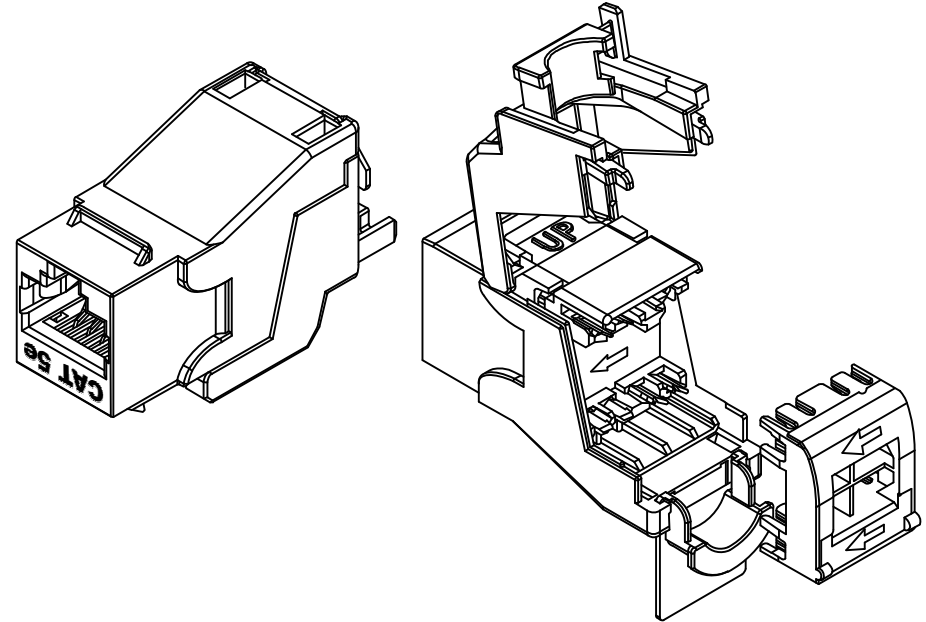
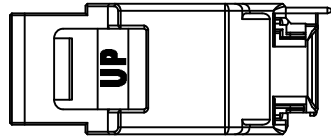
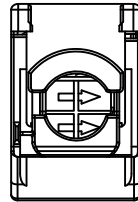
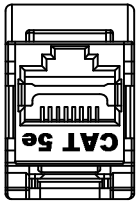
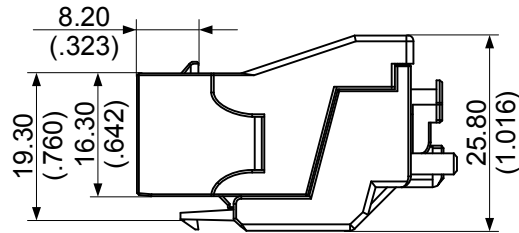
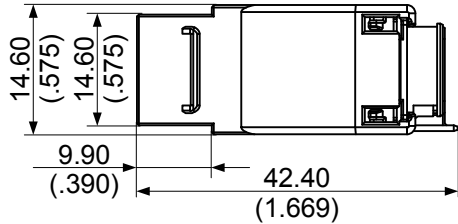
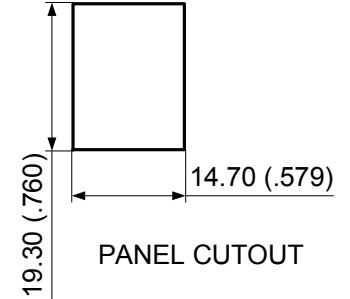

WIRING SCHEMES

UNLESS OTHERWISE SPECIFIED
DIMENSIONS ARE IN MILLIMETERS (INCHES)
TOLERANCES: MM IN ANGULAR

0.0: ±0.2 0.0: ±0.016 0 ±1°
0.00: ±0.1 0.00: ±0.008 0.0 ±0.5°
0.000: ±0.004

MATERIAL: AS NOTES
MECHANICAL: AS NOTES
ELECTRICAL: AS NOTES



| | | | |
|----------------------|----------|-----------------------------|--------|
| PROJECT ID SPCS - PD | | FILE SPCS - PD.KJS458TL-C5E | MAY'10 |
| PROCESS | INITIALS | NAME | DATE |
| DRAWN | | | |
| CHECK | | | |
| APPROVED | | | |

| | | | |
|---|-----------|--------------|--------------|
| 16295 NW 13th Ave, Ste A, Miami, FL 33169, PH: (305) 944-7710, FX: (305) 949-4483, www.signamax.com | | | |
| TITLE KJS458TL-C5E (CAT5E SCREENED TOOLLESS KEYSTONE JACK) | | | |
| SIZE A | CAGE CODE | DWG. NO. | REV A |
| SCALE | 1:1 | UNIT MM (IN) | SHEET 1 OF 1 |